

Ontario Fire Code

SECTION 5.11 *COMBUSTIBLE FIBRES*

Illustrated Commentary



*Office of the
Ontario
Fire Marshal*

5.11.1. Storage

Building sizes

5.11.1.1. **Buildings** used for the storage and handling of baled **combustible fibres** shall comply with the height and area limitations of the **Building Code** for Group 'F' Division 2 **occupancies**.

The Building Code classifies industrial occupancies into 3 divisions.

These include:

- High Hazard Group F Division 1,
- Medium Hazard Group F, Division 2, and
- Low Hazard Group F, Division 3.

Even though warehouses are classified as Group F, Division 2 or 3, depending upon their combustible loading, the Fire Code classifies a building containing combustible fibres as a Group F, Division 2 occupancy because of the inherent flash fire hazard.

Application of this requirement is intended to prevent or minimize fire spread and collapse caused by a fire.

To apply this requirement, refer to the applicable articles contained in subsection 3.2.2. of the Building Code that apply to Group F, Division 2 structures.

Building means any structure used or intended for supporting or sheltering any use or occupancy.

Building Code means the **Ontario Building Code** made under the **Building Code Act** or a predecessor to that Act.

Combustible fibres means finely divided combustible vegetable or animal fibres and thin sheets or flakes of such materials that in a loose, unbaled condition present a flash fire hazard, and includes cotton, wool, hemp, sisal, jute, kapok, paper and cloth.

Occupancy means the use or intended use of a building or part thereof for the shelter or support of persons, animals or property.

5.11.1 Storage

Loose fibre storage

- 5.11.1.2.(1) Up to 3 m³ of loose **combustible fibres** may be kept in any **building** provided storage is in a container complying with Article 2.4.1.9. and 2.4.1.10.
- (2) Quantities of loose **combustible fibres** exceeding 3 m³ but not exceeding 15 m³ shall be stored in rooms separated from the remainder of the **building** by a **fire separation** having a 1-hr **fire-resistance rating**.
- (3) Quantities of loose **combustible fibres** exceeding 15 m³ but not exceeding 30 m³ shall be stored in rooms separated from the remainder of the **building** by a **fire separation** having a 2-hr **fire-resistance rating**.
- (4) Quantities of more than 30 m³ of loose **combustible fibres** shall not be stored in an individual room unless the room is **sprinklered** and separated from the remainder of the **building** by a **fire separation** having a 2-hr **fire-resistance rating**.

Recognizing that combustible fibres may be present in a loose condition, the measures outlined in this requirements are intended to minimize damage that may result in the event of a fire. This is accomplished by limiting the quantities of loose combustible fibres permitted in a building based upon the level of protection provided.

Quantity permitted

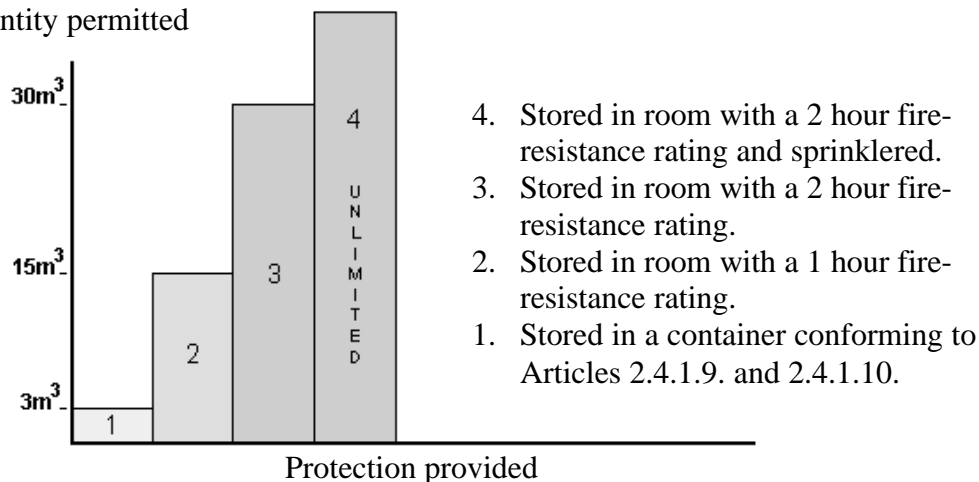

Building means any structure used or intended for supporting or sheltering any use or occupancy.

Combustible fibres means finely divided combustible vegetable or animal fibres and thin sheets or flakes of such materials that in a loose, unbaled condition present a flash fire hazard, and includes cotton, wool, hemp, sisal, jute, kapok, paper and cloth.

Fire separation means a construction assembly that acts as a barrier against the spread of fire and may or may not have a fire-resistance rating or a fire-protection rating.

Fire-resistance rating means the time in hours or fraction thereof that a material or assembly of materials will withstand the passage of flame and the transmission of heat when exposed to fire under specified conditions of test and performance criteria, or as determined by extension or interpretation of information derived therefrom as prescribed in the Building Code.

Sprinklered (as applying to a building or part thereof) means that the building or part thereof is equipped with a system of automatic sprinklers.

5.11.1. Storage

Baled fibre storage

- 5.11.1.3.(1) Baled **combustible fibres** shall be stored so that
- (a) a single pile will not contain more than 700 m^3 ,
 - (b) the maximum height of any single pile will not exceed 4.5 m ,
 - (c) piles are separated by aisles not less than 1.5 m wide, and
 - (d) the clearance between piles and **building** walls is not less than 1 m .

Clauses (a) (b) and (c) are intended to facilitate fire fighting efforts by limiting the fire load in any particular pile and providing access to the piles.

Clause (d) is intended to prevent structural failure of the walls caused by the expansion of the baled fibres when they become wet.

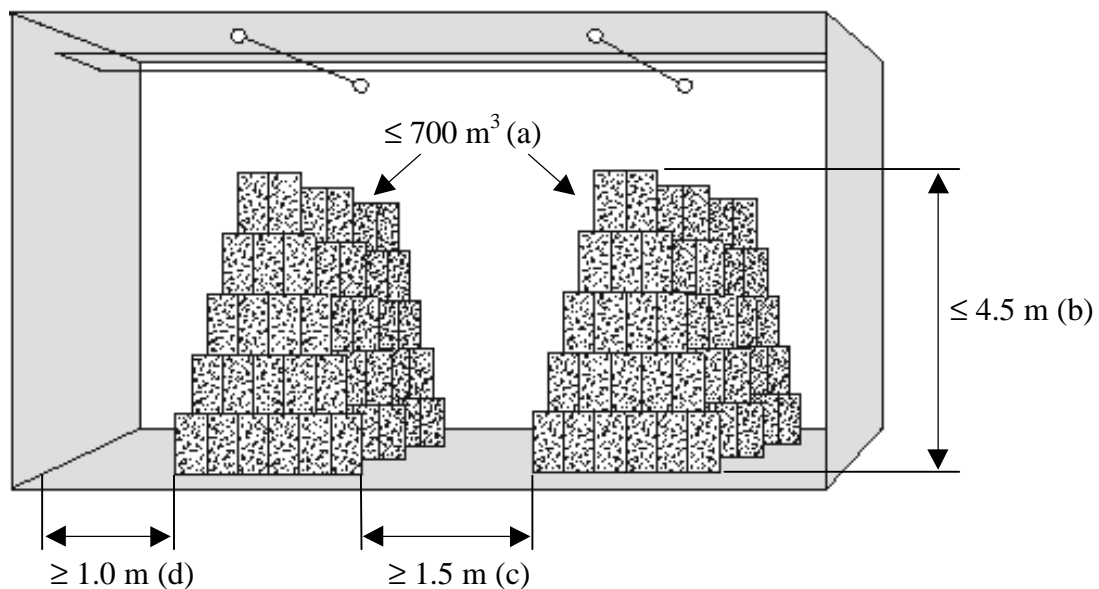

Building means any structure used or intended for supporting or sheltering any use or occupancy.

Combustible fibres means finely divided combustible vegetable or animal fibres and thin sheets or flakes of such materials that in a loose, unbaled condition present a flash fire hazard, and includes cotton, wool, hemp, sisal, jute, kapok, paper and cloth.

5.11.1. Storage

Baled storage piles

- 5.11.1.4. The sides of baled storage piles shall be inclined back from the base of the pile with a slope of not less than 1 m for each 10 m of height.

Baled combustible fibres will expand when they become wet and may become unstable. Some combustible fibres may absorb their own weight in water. It is important therefore to arrange the storage piles in an inclined manner. This will reduce the likelihood of the pile collapsing. This would require the setback of 0.45 meters for a pile having a maximum height of 4.5 meters.

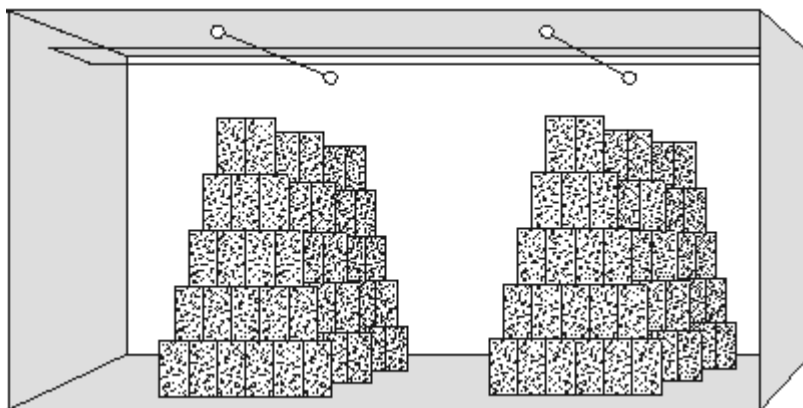

5.11.1. Storage

Baled storage piles

- 5.11.1.5.(1) The clearance between the sprinkler head deflectors and the tops of piles shall not be less than 457 mm.
- (2) Where the storage piles are above the lower chords of floor or roof structural framing members, a horizontal clear space of 300 mm shall be maintained between the storage and the structural members.

Sentences (1) and (2) are intended to ensure that water discharging from automatic sprinklers or from a hand-held hose is not obstructed by the stored baled materials.

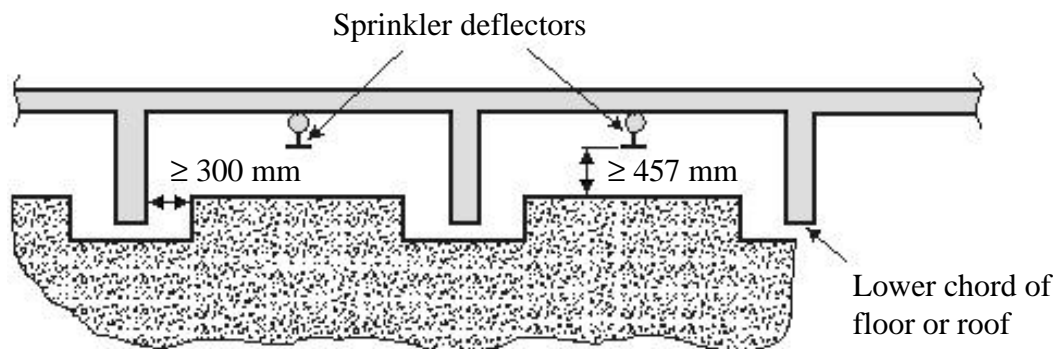

5.11.1. Storage

Heating equipment

- 5.11.1.6.(1) Storage areas for **combustible fibres** shall not contain fuel fired **appliances** or electrical heating elements.
- (2) Shields shall be provided that will prevent stored material from coming within 300 mm of any part of the heating system.

These requirements are intended to minimize the possibility of heating equipment becoming a source of ignition in areas where combustible fibres are stored.

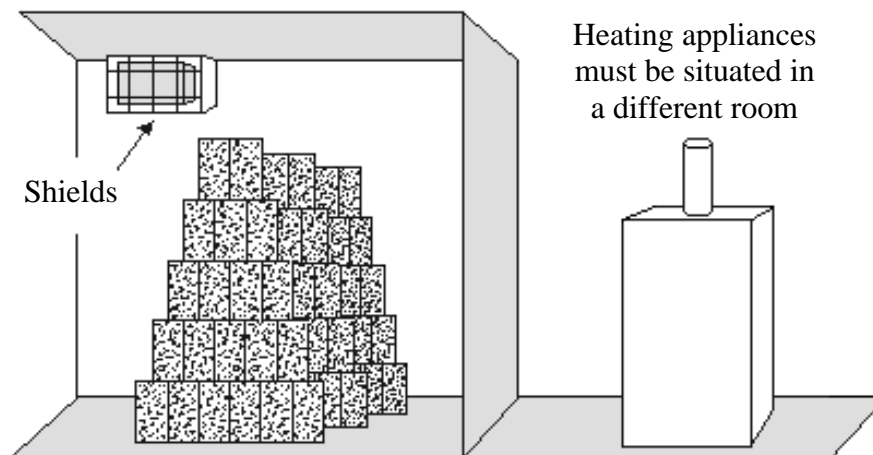

Appliance means a device to convert fuel into energy, and includes all components, controls, wiring and piping required to be part of the device by the applicable standard referred to in this Code.

Combustible fibres means finely divided combustible vegetable or animal fibres and thin sheets or flakes of such materials that in a loose, unbaled condition present a flash fire hazard, and includes cotton, wool, hemp, sisal, jute, kapok, paper and cloth.

5.11.2. Fire Protection

Standpipe and hose system installations

- 5.11.2.1. **Combustible fibres** shall be stored only in warehouses which are protected by standpipe and hose systems installed in conformance with the **Building Code**.

Since a fire involving combustible fibres has the potential to spread rapidly, it is mandatory for a warehouse containing stored combustible fibres to be equipped with a fire standpipe system. A standpipe system conforming to the Building Code would provide the necessary water supply, fire hoses and related equipment that would be used to fight a fire.

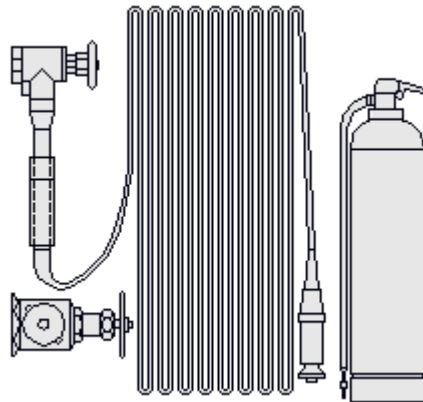

Building Code means the **Ontario Building Code** made under the **Building Code Act** or a predecessor to that Act.

Combustible fibres means finely divided combustible vegetable or animal fibres and thin sheets or flakes of such materials that in a loose, unbaled condition present a flash fire hazard, and includes cotton, wool, hemp, sisal, jute, kapok, paper and cloth.

5.11.2. Fire Protection

Portable extinguishers

- 5.11.2.2. Portable extinguishers shall be provided in conformance with Section 6.2.

This requirement is a reminder to owners that portable fire extinguishers must be provided as required by Section 6.2.

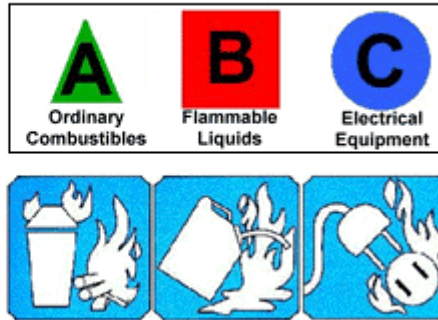

5.11.2. Fire Protection

Smoke vents

- 5.11.2.3. Where **combustible fibres** are stored in **buildings**, automatic smoke venting hatches manually operable from remote locations and having a combined opening area of 64 cm^2 for each square metre of **floor area** shall be provided.

Smoke venting hatches let smoke and hot gases escape from a building to allow more effective manual fire fighting.

Typically, local smoke detectors or fusible links are the devices used to automatically open smoke vents in the vicinity of the fire. The smoke venting hatches must also be manually operable from remote locations.

The combined size of the smoke venting hatches is determined by the size of the building floor area (64 cm^2 for each square metre of floor area). For example, a floor area of 1000 square metres would require 6.4 square metres of smoke venting.



Building Code means the **Ontario Building Code** made under the **Building Code Act** or a predecessor to that Act.

Combustible fibres means finely divided combustible vegetable or animal fibres and thin sheets or flakes of such materials that in a loose, unbaled condition present a flash fire hazard, and includes cotton, wool, hemp, sisal, jute, kapok, paper and cloth.

Floor Area means the space on any storey of a building between exterior walls and required firewalls and includes the space occupied by interior walls and partitions, but does not include exits and vertical service spaces that pierce the storey.

- Q1 What is meant by combustible fibres?
A1 Combustible fibres means finely divided combustible vegetable or animal fibres and thin sheets or flakes of such materials that in a loose, unbaled condition present a flash fire hazard, and includes cotton, wool, hemp, sisal, jute, kapok, paper and cloth.
- Q2 How should baled combustible fibres be stored?
A2 Refer to Ontario Fire Code 5.11.1.3. to 5.11.1.5.
- Q3 Should storage areas for combustible fibres contain electrical heating elements or fuel fired appliances?
A3 Refer to Ontario Fire Code 5.11.1.6.
- Q4 What is the purpose of the standpipe and hose system with respect to combustible fibres?
A4 Refer to Ontario Fire Code 5.11.2.1.
- Q5 What is the purpose of smoke vents in buildings where combustible fibres are stored?
A5 Refer to Ontario Fire Code 5.11.2.3.
-